

Hmyzie hotely

ŠVOČ

Konzultant : Ing. Iveta Melicherčíková

Autori : Vladimíra Voskárová, Bc. Peter Kortiš, Bc. Jakub Cvitkovič



Filozofia práce

- Exteriérové prvky- hmyzie hotely
- Funkcie: informovanie verejnosti, obydlie určené pre hmyz
- Lokality: Zlatý Potok, Zvolen- Západ

Kľúčové slová :

Dizajn/ Exteriér/ Hotel/ Hmyz/ Drevo



Podujatie sa koná vďaka finančnej podpore
Fondu dm drogerie markt v nadácii Pontis
a Green Foundation.





3 Domy

Návrh hmyzieho hotela









Inšpirovala som sa hlavne rôznorodosťou a členitosťou zástavby, pričom som chcela poukázať a upozorniť na fakt, že aj hmyz potrebuje svoj životný priestor.

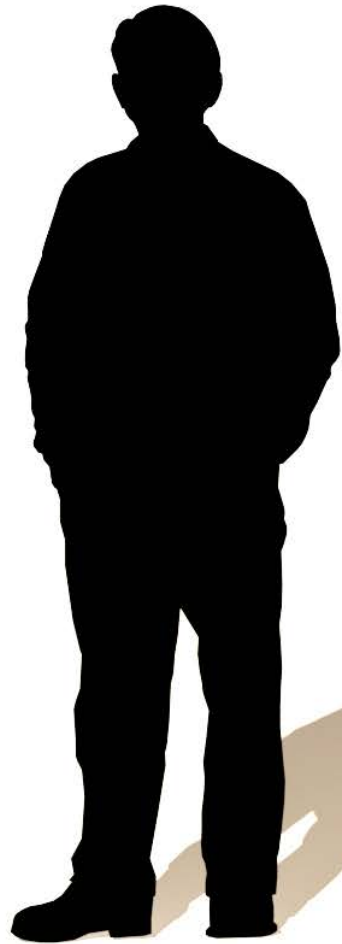

Tvarovanie hmyzieho hotela vychádza zo štylizácie panelového domu, ktorý je rozčlenený na jednotlivé bunky. Tento objekt by mal zapadnúť do okolitého prostredia a nekonkurovať mu. Byť jednoduchý, ale zároveň aj praktický. Pôsobiť príjemne a nenásilne.



Súčasťou návrhu je priestor na zasadenie rastliny, umiestený v najvyššej časti hotela. Zelen poskytuje oživenie, ale zároveň má aj svoju funkciu.



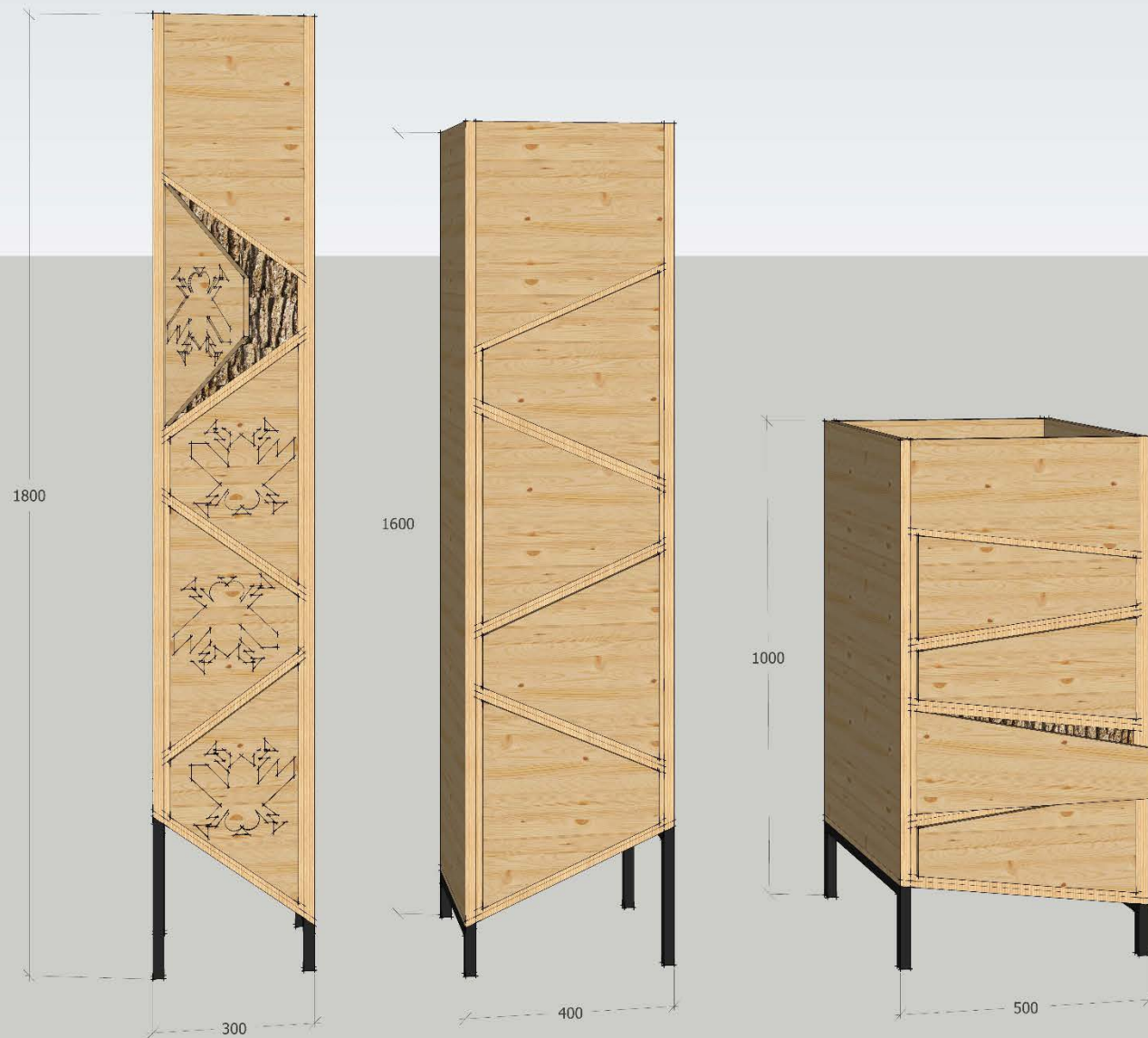

Zaujímavým prvkom je grafické spracovanie hmyzu v tradičnom ornamentálnom vzore. Jej hlavnou témou je zoštylizovaný hmyz, ktorý by bol vytvorený na dvierkach.



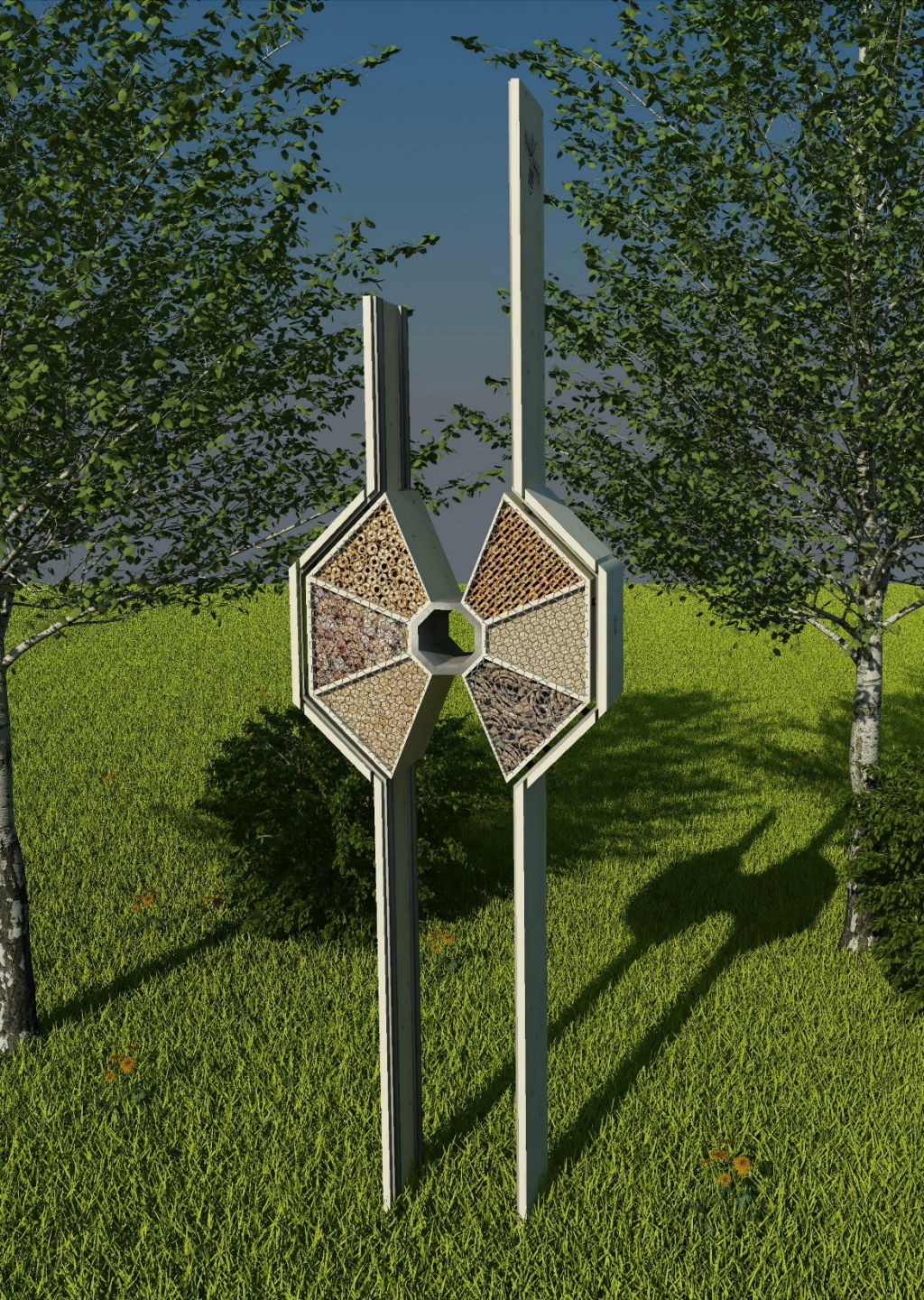

Totem

Návrh hmyzieho hotela



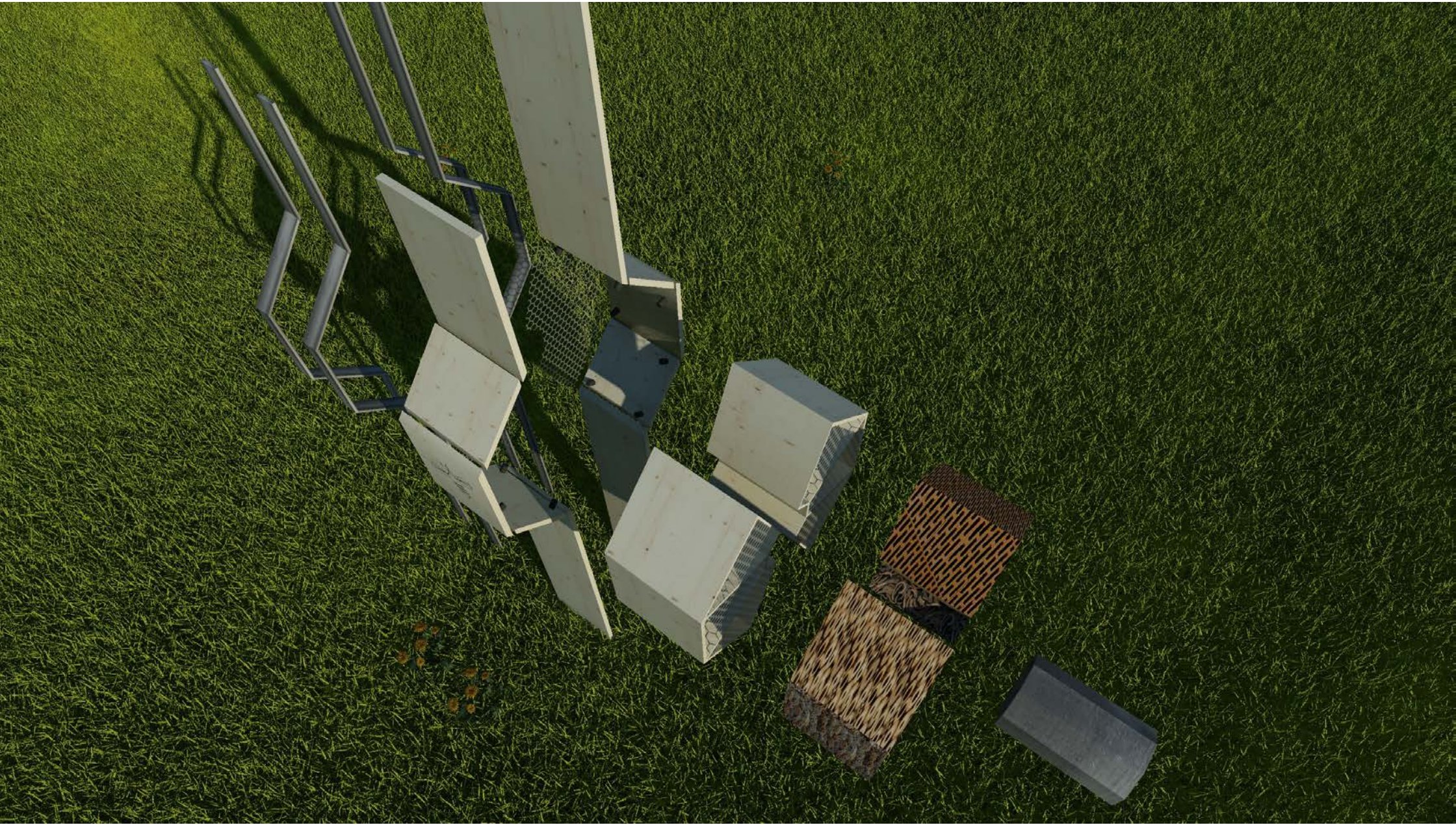

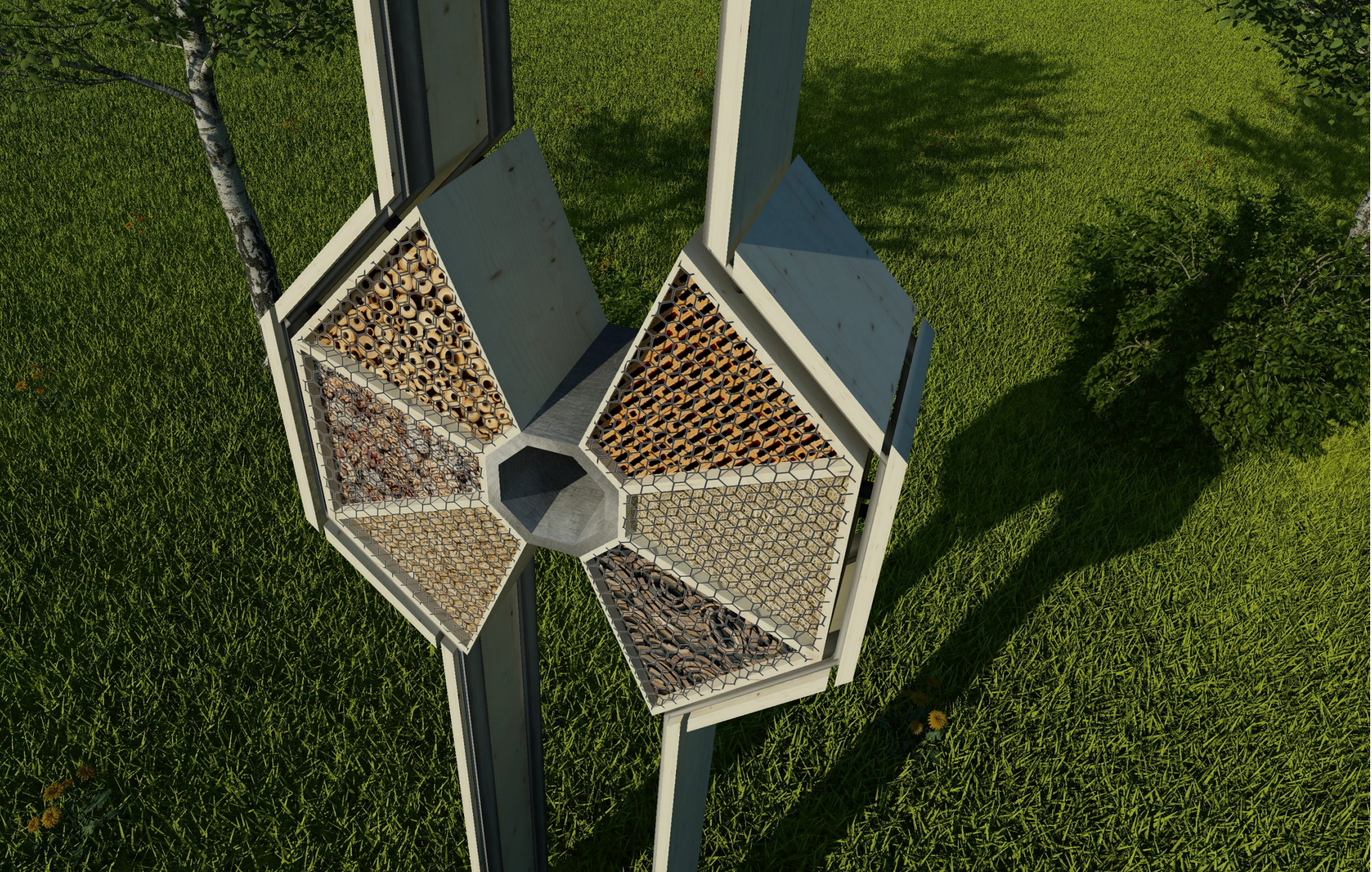

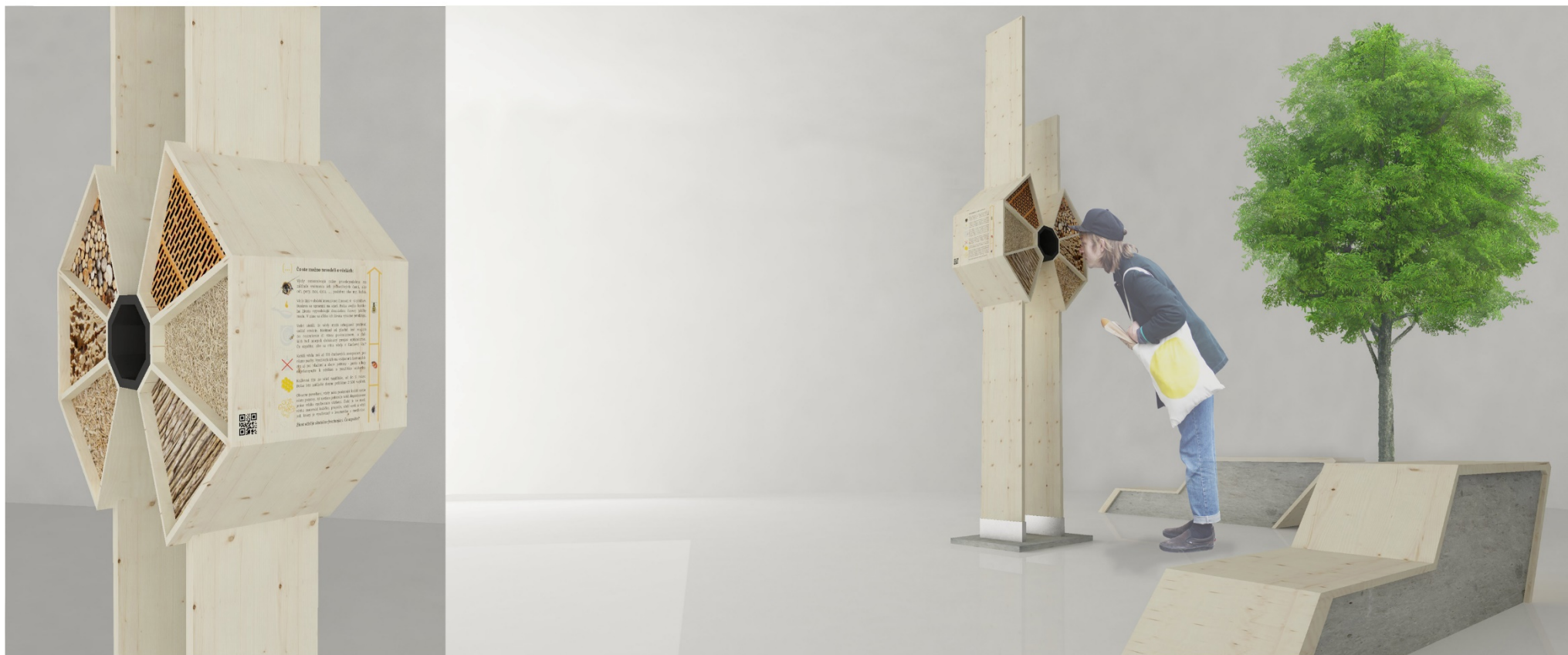

Návrh hmyzieho hotela pre funkcie informovania verejnosti, kukátka a obydlia pre rôzne druhy hmyzu, bol navrhnutý na základe analýzy prostredia v ktorom bude osadený a podľa mnohých faktorov, ktoré ovplyvnili jeho tvar a materiálové prevedenie.





Hmyzí hotel pôsobí dominantným monumentálnym dojmom pričom nenarúša ráz okolia v ktorom sa nachádza. Jeho hlavná časť bola inšpirovaná šesťuholníkovým tvarom.



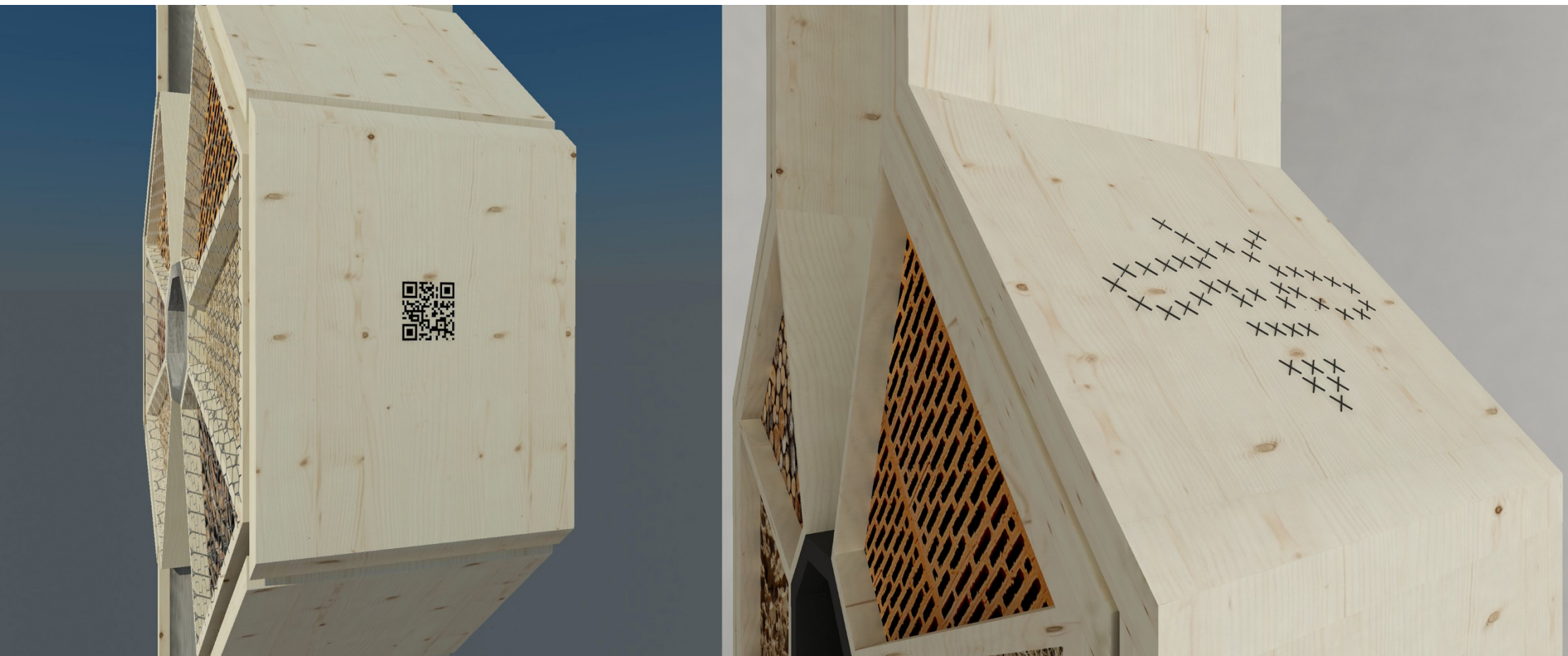

Hlavným použitým materiálom je smrekové drevo a oceľ, ktorá plní stabilizačnú a odolnú funkciu hotela.

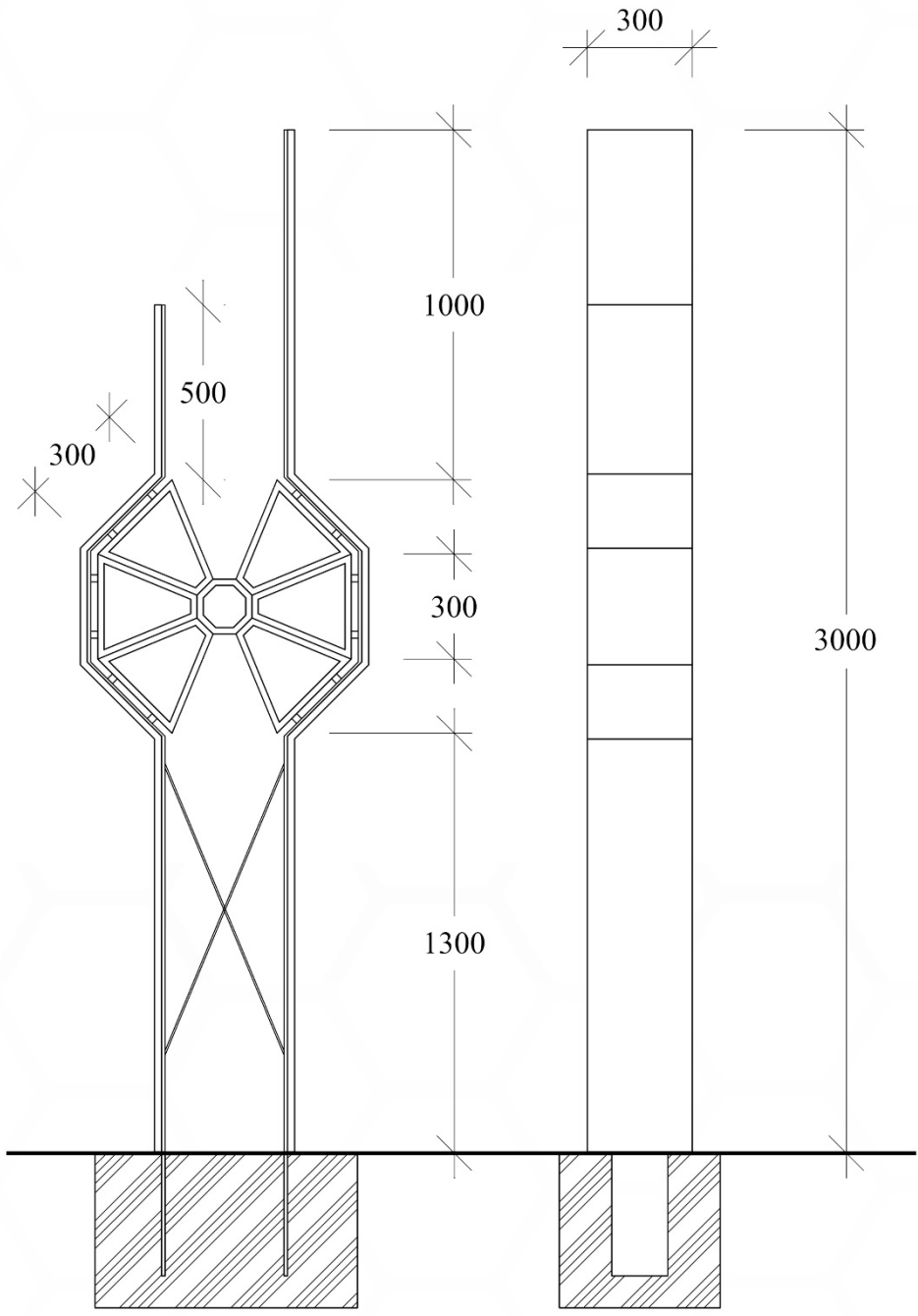



Maják

Návrh hmyzieho hotela



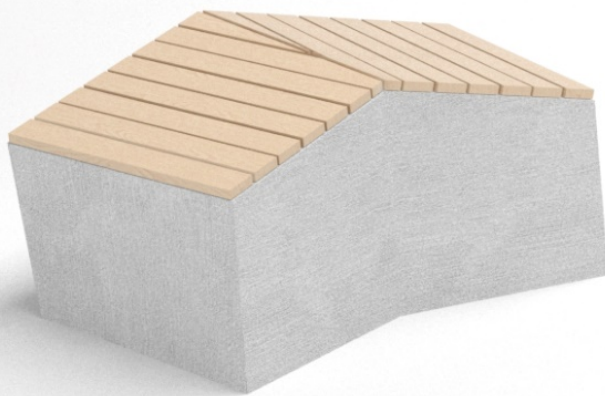
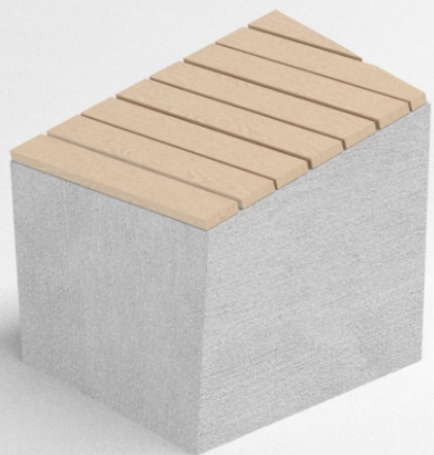

VČELY V MESTE

Niektoré druhy sárk
tárok sú viazané
výhradne na určitý
druh rastlín. Vyliezu
z dutiniek až v dobe
kedy tieto rastliny
kvitnú a celý proces
rozmnožovania, kl



Dominatný prvok s opracovaným kmeňom stromu.

Jednoduchý dizajn nenarušující ráz krajiny.





Tvarová návaznosť na objekt majáku.



360 stupňový objekt ako útočisko pre hmyz.



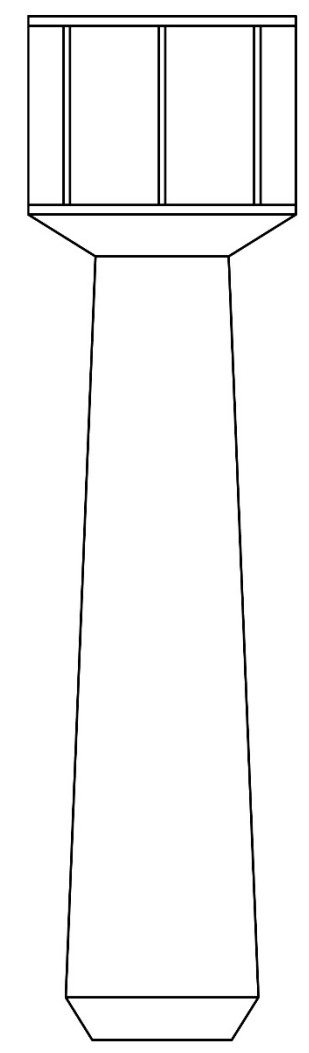

1750

Ďakujeme za pozornost.

